

تم تحميل وعرض هذا المادة من موقع واجبي:

wajibi.com



www.wajibi.net

واجبي موقع تعليمي يوفر مجموعة واسعة من الخدمات والموارد التعليمية، يهدف موقع واجبي إلى تسهيل عملية التعليم ويقدم حلول المناهج للطلاب في جميع المراحل الدراسية.

حمل تطبيق واجبي من هنا  يصلك كل جديد



اوراق عمل

“

We Can 1

الصف الأول الابتدائي
الفصل الدراسي الثالث

”

الاسم /

الفصل /

1st Grade Unit 1 Skills Evaluation

3rd TERM

Name

Class.....

1-Write guided short answers to written questions . مهارة: كتابة الاجابة على الأسئلة.

Answer:-

1- Do you have a pet?



2- Do you have a pet?



2-Utter simple words and numbers (cardinal numbers 1-19) مهارة: معرفة الأرقام من 1-19

Count the numbers of the drinks , then circle the number next to it.

	9	12	13
	2	6	1
	8	10	6
	3	19	14
	16	10	11
	18	5	4

3- مهارة: الاستماع لمقطع صوتي. Be willing to listen to short prepared digital and recoded

Listen to PACO chant then answer :

1-PACO is a (rabbit , horse , sheep)

2-There was a (farmer , teacher , doctor) who had a horse.

3-The horse's name is (S-A-B-O / P-A-C-O / D-A-C-O)

4- مهارة: التحدث عن الطعام, الحيوان, الملابس. Identify and talk about food, animals, clothes

5- مهارة: قراءة الكلمات والتوصيل بالصورة. Read and match words to photos/drawings

Write then match:

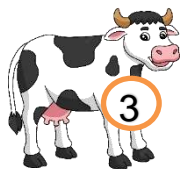
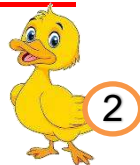

1-RBID

○

2-PEESH

○

3-UCKD

○

4-HSIF

○

5-OWC

○

6- مهارة: التعرف على الأصوات وتوصيلها بالحروف. Recognize and match sounds to letters.

Circle then write the word:

1- 

U	S
V	T



2- 

U	S
V	T



3- 

U	S
V	T



4- 



U	S
V	T



7- مهارة: نسخ كلمات وأرقام وجمل. Copy words, numbers and simple short sentences.

8- مهارة: معرفة واتقان الكتابة بين السطور. Use lined paper correctly with headline, midline, and baseline.

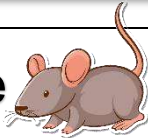
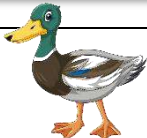
9- مهارة: معرفة واتقان الحروف الكبيرة والصغيرة. Write upper/lower case letters correctly.

Chicken 	Mouse 	Duck 	Horse 
<hr/> <hr/> <hr/>	<hr/> <hr/> <hr/>	<hr/> <hr/> <hr/>	<hr/> <hr/> <hr/>
<hr/> <hr/> <hr/>	<hr/> <hr/> <hr/>	<hr/> <hr/> <hr/>	<hr/> <hr/> <hr/>

Copy

21

11

16

30

1st Grade Unit 2 Skills Evaluation

3rd TERM

Name

Class.....

مهارة: كتابة الاجابة على الأسئلة. 1-Write guided short answers to written questions



Answer:-

1- What day do you like?

2- Do you like Friday?

مهارة: معرفة الأرقام من 10-100 2-Read and count numbers in tens (10-100)

Count the tens , then circle the number next to it.

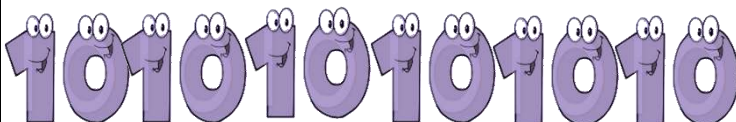
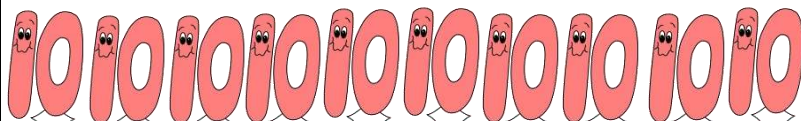
	10	20	30
	20	30	50
	60	80	40
	10	100	70

3- مهارة: الاستماع لمقطع صوتي. Be willing to listen to short prepared digital and recoded

Listen to Days of the week chant then answer :

1-Saturday , Sunday,.....

2-The day after Wednesday is.....

3-The day before Saturday is

4- مهارة: قراءة الكلمات والتوصيل بالصورة. Read and match words to photos/drawings

Write then match:

1-Sunny



2-Cloudy



3-Rainy

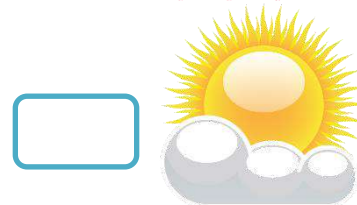

4-Snowy



5-Windy



مهارة: التعرف على الأصوات وتوصيلها بالحروف. 5- Recognize and match sounds to letters.

Circle

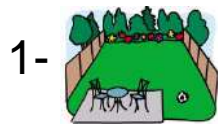

W	X
Y	Z

then write the word:



W	X
Y	Z



W	X
Y	Z

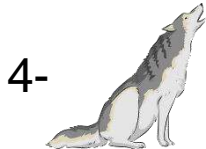



W	X
Y	Z

مهارة: نسخ كلمات وأرقام وجمل. 6- Copy words, numbers and simple short sentences.

مهارة: معرفة واتقان الكتابة بين السطور. 7- Use lined paper correctly with headline, midline, and baseline.

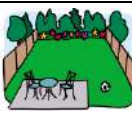
مهارة: معرفة واتقان الحروف الكبيرة والصغيرة. 8- Write upper/lower case letters correctly.

Wolf 	Yard 	Zebra 	Fox 
_____	_____	_____	_____
-----	-----	-----	-----
_____	_____	_____	_____
-----	-----	-----	-----
_____	_____	_____	_____
-----	-----	-----	-----
_____	_____	_____	_____
-----	-----	-----	-----

Copy

60

30

40

100

1st Grade Unit 3 Skills Evaluation

3rd TERM

Name

Class.....

1-Recognise intonation patterns of statements and questions مهارة: معرفة الفرق بين
الجملة والسؤال

Answer:-



1- Are you happy?

.....

.....

2- Talk about feelings in simple and short sentences مهارة: التحدث عن المشاعر في جمل
بسيطة وقصيرة

Think then answer :-

1- What is the matter?

A-

.....

.....



B-

.....

.....



C-

.....

.....



D-

.....

.....



3- Read aloud simple words and sentences .مهارة: قراءة كلمات وجمل قصيرة.

Read Then match:-

1-Glasses 2-Caps

3-Shoes 4-Skirts

5-Trousers 6-T-shirts

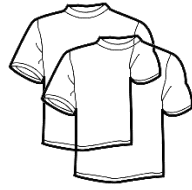

4- Recognize and apply regular plural formation using (these and those) مهارة: معرفة وتطبيق أسماء الإشارة (الجمع للقريب والبعيد).

Choose the demonstrative :

1-(These / Those) are caps



2-(These / Those) are shoes



5-Recognize prepositions of place (in, on) مهارة: معرفة حروف جر المكان

Read then Choose:-

1-The ball is (in / on) the box.



2-The ball is (in / on) the box.



6- Recognize and differentiate between some English letters (b & p), (f & v) مهارة: معرفة وتمييز بعض الحروف المتشابهة

Look at the picture then circle the correct sound:-

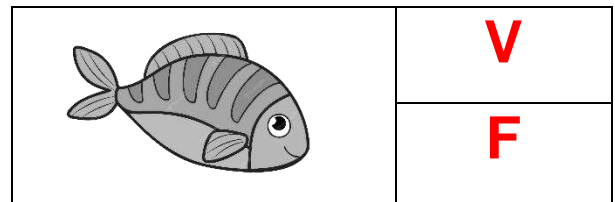
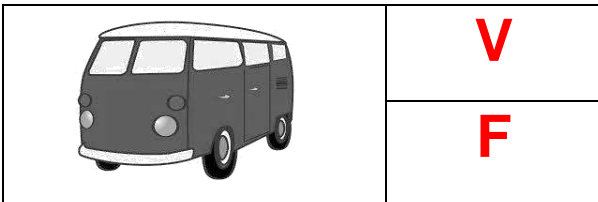
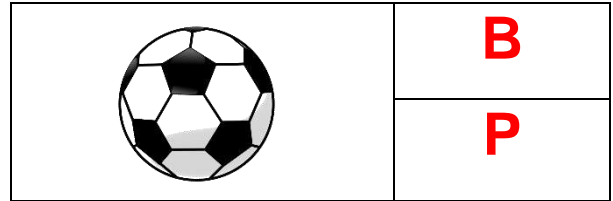
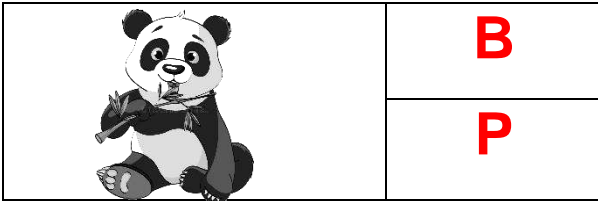



7- Recognise and produce only some English digraphs such as, (th, sh, ch) مهارة: معرفة واتقان حرفين متتالين .

Fill in:-

1- _____ ip. 

Th-Ch-Sh

2- _____ ree. 

3- _____ eeze. 

4- _____ is. 

الحلول

اوراق عمل

We Can 1

الصف الأول الابتدائي

الفصل الدراسي الثالث

الاسم /

الفصل /

1st Grade Unit 1 Skills Evaluation

3rd TERM

Name

Class.....

مهارة: كتابة الاجابة على الأسئلة. 1-Write guided short answers to written questions

Answer:-

1- Do you have a pet?



Yes, I have. I have a turtle.

2- Do you have a pet?



No, I don't have.

مهارة: معرفة الأرقام من 1-19 (cardinal numbers 1-19) 2-Utter simple words and numbers

Count the numbers of the drinks, then circle the number next to it.

	9	12	13
	2	6	1
	8	10	6
	3	19	14
	16	10	11
	18	5	4

مهارة: الاستماع لمقطع صوتي. 3- Be willing to listen to short prepared digital and recoded

Listen to PACO chant then answer :

1-PACO is a (rabbit , horse , sheep)

2-There was a (farmer , teacher , doctor) who had a horse.

3-The horse's name is (S-A-B-O / P-A-C-O / D-A-C-O)

مهارة: التحدث عن الطعام, الحيوان, الملابس. 4- Identify and talk about food, animals, clothes

مهارة: قراءة الكلمات والتوصيل بالصورة. 5- Read and match words to photos/drawings

Write then match:

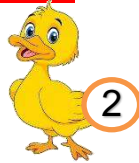

1-RBID

Bird

4

2-PEESH

Sheep

6

3-UCKD

Duck

2

4-HSIF

Fish

1

5-OWC

Cow

3

6-TAC

Cat

5

6- Recognize and match sounds to letters. مهارة: التعرف على الأصوات وتوصيلها بالحروف.

Circle then write the word:

1- 

U	S
V	T

 → Sun

2- 

U	S
V	T

 → Tiger

3- 

U	S
V	T

 → Umbrella

4- 



U	S
V	T

 → Vase

7- Copy words, numbers and simple short sentences. مهارة: نسخ كلمات وأرقام وجمل.

8- Use lined paper correctly with headline, midline, and baseline. مهارة: معرفة واتقان الكتابة بين السطور.

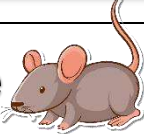
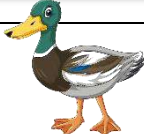
9- Write upper/lower case letters correctly. مهارة: معرفة واتقان الحروف الكبيرة والصغيرة.

Chicken 	Mouse 	Duck 	Horse 
<u>Chicken</u>	<u>Mouse</u>	<u>Duck</u>	<u>Horse</u>
_____	_____	_____	_____
_____	_____	_____	_____

Copy

21	11	16	30
<u>21</u>	<u>11</u>	<u>16</u>	<u>30</u>
_____	_____	_____	_____



1st Grade Unit 2 Skills Evaluation

3rd TERM

Name

Class.....

1-Write guided short answers to written questions .مهارة: كتابة الاجابة على الأسئلة.

Answer:-

1- What day do you like?



I like Thursday.

2- Do you like Friday?

Yes, I do.

2-Read and count numbers in tens (10-100) 100-10 مهارة: معرفة الأرقام من

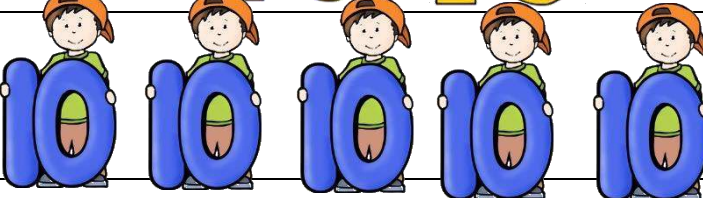
Count the tens , then circle the number next to it.

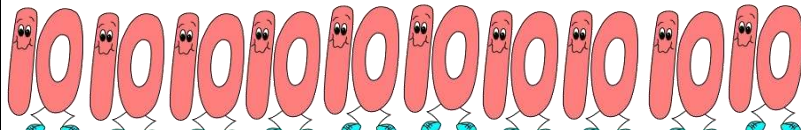
	10	20	30
	20	30	50
	60	80	40
	10	100	70

3- مهارة: الاستماع لمقطع صوتي. Be willing to listen to short prepared digital and recoded

Listen to Days of the week chant then answer :

1-Saturday , Sunday,.....**Monday**.....

2-The day after Wednesday is.....**Thursday**.....

3-The day before Saturday is**Friday**.....

4- مهارة: قراءة الكلمات والتوصيل بالصورة. Read and match words to photos/drawings

Write then match:

1-Sunny

Sunny

2-Cloudy

Cloudy

3-Rainy

Rainy

4-Snowy

Snowy

5-Windy

Windy

4



3



1



5



2



5- مهارة: التعرف على الأصوات وتوصيلها بالحروف. Recognize and match sounds to letters.

Circle

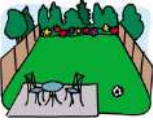
1- 

W	X
Y	Z

then write the word: Yard

2- 

W	X
Y	Z

then write the word: Fox

3- 

W	X
Y	Z

then write the word: Zebra

4- 

W	X
Y	Z

then write the word: Wolf

6- مهارة: نسخ كلمات وأرقام وجمل. Copy words, numbers and simple short sentences.

7- مهارة: معرفة واتقان الكتابة بين السطور. Use lined paper correctly with headline, midline, and baseline.

8- مهارة: معرفة واتقان الحروف الكبيرة والصغيرة. Write upper/lower case letters correctly.

Wolf 	Yard 	Zebra 	Fox 
<u>Wolf</u>	<u>Yard</u>	<u>Zebra</u>	<u>Fox</u>
<u>Wolf</u>	<u>Yard</u>	<u>Zebra</u>	<u>Fox</u>

Copy

<u>60</u>	<u>30</u>	<u>40</u>	<u>100</u>
<u>60</u>	<u>30</u>	<u>40</u>	<u>100</u>

1st Grade Unit 3 Skills Evaluation

3rd TERM

Name

Class.....

1-Recognise intonation patterns of statements and questions مهارة: معرفة الفرق بين
الجملة والسؤال

Answer:-



1- Are you happy?

Yes, I am

2- Talk about feelings in simple and short sentences مهارة: التحدث عن المشاعر في جمل
بسيطة وقصيرة

Think then answer :-

1- What is the matter?

A-

I am thirsty.



B-

I am sad.



C-

I am angry.



D-

I am hungry.



3- Read aloud simple words and sentences مهارة: قراءة كلمات وجمل قصيرة.

Read Then match:-

1-Glasses 2-Caps

3-Shoes 4-Skirts

5-Trousers 6-T-shirts



2



3

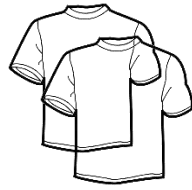

6



4



5



1

4- Recognise and apply regular plural formation using (these and those) مهارة: معرفة وتطبيق أسماء الإشارة (جمع للقریب والبعید).

Choose the demonstrative :

1-(**These** / Those) are caps



2-(These / **Those**) are shoes



5-Recognize prepositions of place (in, on) مهارة: معرفة حروف جر المكان

Read then Choose:-

1-The ball is (**in** / on) the box.



2-The ball is (in / **on**) the box.



6- مهارة: معرفة وتمييز بعض الحروف المتشابهة (b & p), (f & v)

Look at the picture then circle the correct sound:-

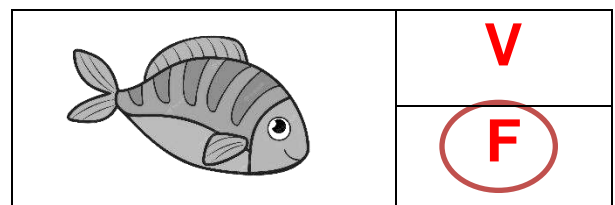
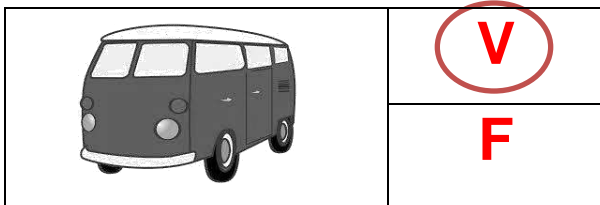
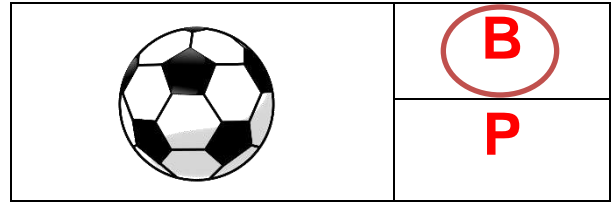
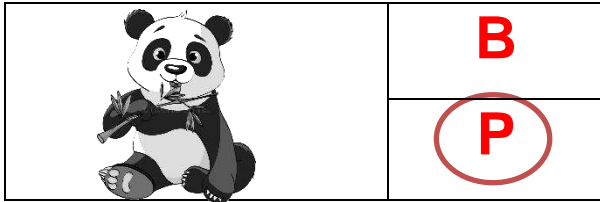

7- مهارة: معرفة واتقان حرفين (th, sh, ch) متتالين .

Fill in:-

1- **Sh** ip. 

Th-Ch-Sh

2- **Th** ree. 

3- **Ch** eeze. 

4- **Th** is. 

ENGLISH

أوراق عمل

لجميع وحدات الفصل الدراسي الثالث

للسف الأول الابتدائي

(لغة انجليزية)

	الاسم / الفصل /
--	--------------------





Worksheet



1st grade

Unit 1

Animals

Name

Class

رقم المهارة

9

التقييم

غير مجتاز	متمكن	متقدم	متفوق

1 – Do you have a pet?

A. I am ten.

B. Yes, I do. I have a cat.



رقم المهارة

21

التقييم

غير مجتاز	متمكن	متقدم	متفوق

Read and Match:

11

13

20

15

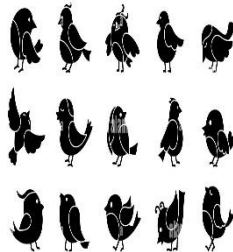

رقم المهارة

29, 30, 32

التقييم

غير مجتاز	متمكن	متقدم	متفوق

Copy the following sentence:

There was a farmer.

.....

.....

رقم المهارة

18 , 23

التقييم



غير مجتاز

متمكن

متقدم

متفوق

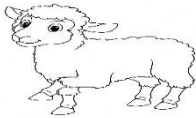
Read and Choose:

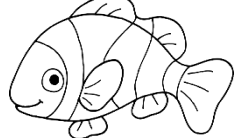
				
cat	sheep	bird	chicken	bird
duck	horse	cow	mouse	fish

رقم المهارة

31 , 1

التقييم

غير مجتاز

متمكن

متقدم

متفوق

read and complete the letters:

S	
T	

	u
	v

Y	
	a

رقم المهارة

26 , 34

التقييم





غير مجتاز

متمكن

متقدم

متفوق

Choose the correct letter:

			
_mbrella	_ase	_iger	_un
u	v	d	c
v	f	t	s

Good luck

T.



Worksheet



1st grade

Unit 1

Animals

Name

Class

ترجمتها	المهارة / رقمها
يسأل ويجيب عن اسئلة عامة واساسية	Ask and respond to basic questions <u>9</u>
نطق كلمات وأرقام بسيطة (الأرقام الأساسية 1-19)	Utter simple words and numbers (cardinal numbers 1-19) <u>21</u>
استخدام الورق المسطر والكتابة عليية بشكل صحيح	Use lined paper correctly with headline, midline, and baseline <u>29</u>
نسخ الكلمات والأرقام والجمل القصيرة البسيطة	Copy words , numbers and simple short sentences . <u>30</u>
استخدام المسافات المناسبة بين الكلمات والجمل عند الكتابة .	Use appropriate spacing between words And sentences. <u>32</u>
قراءة الكلمات والجمل البسيطة بصوت عالٍ	Read aloud simple words and sentences <u>23</u>
التحدث والتعرف على الملابس والحيوانات والطعام	Identify and talk about food, animals, clothes <u>18</u>
كتابة الحروف الكبيرة / الصغيرة بشكل صحيح	Write upper / lower case letters correctly <u>31</u>
التعرف على أصوات الحروف وقراءتها	Recognize and produce the sounds of the English alphabet <u>1</u>
تهجئة بعض الكلمات بشكل صحيح وكتابة الحرف الناقص .	Spell some simple sight words correctly. <u>26</u>
القيام بالكتابة المتحكم فيها مثل توريد الحروف والكلمات الناقصة	Do controlled writing such as supplying missing letters and words <u>34</u>



Worksheet



1st grade

Unit 2

Day and Weather

Name

Class

رقم المهارة

9

التقييم

غير مجتاز	متمكن	متقدم	متفوق

1 – What day do you like?

A. I like apple.

B. I like Thursday.

2 – What is the weather like today?

A. It is windy today.

B. It's sunny today.



رقم المهارة

21, 22, 23

التقييم

غير مجتاز	متمكن	متقدم	متفوق

Read and match:

40

3

100

hundred

forty

three

رقم المهارة

29, 30, 32

التقييم

غير مجتاز	متمكن	متقدم	متفوق

Copy the following sentence:





رقم المهارة

18 , 23

التقييم

غير مجتاز	متمكن	متقدم	متفوق

Read and Choose:

			
Rainy	Cloudy	Cloudy	Day
sunny	Rainy	Windy	Weather

رقم المهارة

31 , 1

التقييم

غير مجتاز	متمكن	متقدم	متفوق

read and complete the letters:

R	
J	

	m
	n

L	
	k





رقم المهارة

26 , 34

التقييم

غير مجتاز	متمكن	متقدم	متفوق

Choose the correct letter:

			
Fo__	__ebra	fri__ay	__ard
s	k	d	y
x	z	t	o



Worksheet



1st grade

Unit 2

Day and Weather

Name

Class

ترجمتها	المهارة / رقمها
يسأل ويجيب عن اسئلة عامة واساسية	Ask and respond to basic questions <u>9</u>
نطق كلمات وأرقام بسيطة (الأرقام الأساسية 1-19)	Utter simple words and numbers (cardinal numbers 1-19) <u>21</u>
قراءة وعد الاعداد بالعشرات	Read and count numbers in tens <u>22</u>
قراءة الكلمات والجمل البسيطة بصوت عالٍ	Read aloud simple words and sentences <u>23</u>
استخدام الورق المسطر والكتابة علياً بشكل صحيح	Use lined paper correctly with headline, midline, and baseline <u>29</u>
نسخ الكلمات والأرقام والجمل القصيرة البسيطة	Copy words , numbers and simple short sentences . <u>30</u>
استخدام المسافات المناسبة بين الكلمات والجمل عند الكتابة .	Use appropriate spacing between words And sentences. <u>32</u>
قراءة الكلمات والجمل البسيطة بصوت عالٍ	Read aloud simple words and sentences <u>23</u>
التحدث والتعرف على الملابس والحيوانات والطعام	Identify and talk about food, animals, clothes <u>18</u>
كتابة الحروف الكبيرة / الصغيرة بشكل صحيح	Write upper / lower case letters correctly <u>31</u>
التعرف على أصوات الحروف وقراءتها	Recognize and produce the sounds of the English alphabet <u>1</u>
تهجئة بعض الكلمات بشكل صحيح وكتابة الحرف الناقص .	Spell some simple sight words correctly. <u>26</u>
القيام بالكتابة المتحكم فيها مثل توريد الحروف والكلمات الناقصة	Do controlled writing such as supplying missing letters and words <u>34</u>

Good luck

T.



Worksheet



1st grade

Unit 3

Feelings and Things

Name

Class

رقم المهارة

9, 14

التقييم

غير مجتاز	متمكن	متقدم	متفوق

1 - Are you happy?

A. Yes I am.

B. No, I am not.



2 - What is the matter?

A. I am happy .

B. I am sad .



رقم المهارة

14, 23

التقييم

غير مجتاز	متمكن	متقدم	متفوق

Read and match:

scared



thirsty



hungry



angry







رقم المهارة

12

التقييم

غير مجتاز	متمكن	متقدم	متفوق

Choose correct pronouns for each picture :

			
I	She	He	He
YOU	We	She	She

رقم المهارة

11



التقييم

غير مجتاز	متمكن	متقدم	متفوق

CHOOSE **these - those**

1 - _____ are skirts. 



2 - _____ are caps.  

رقم المهارة

13

التقييم

غير مجتاز	متمكن	متقدم	متفوق

CHOOSE **in - on**

1 - My cap is _____ the bed .





Worksheet



1st grade

Unit 3

Feelings and Things

Name

Class





رقم المهارة

2 , 3 , 4 , 34

التقييم

غير مجتاز	متمكن	متقدم	متفوق

Choose the correct letter:

				
_ _ ips	_ _ ear	_ _ an	_ _ an	_ _ all
Sh	B	f	v	B
Ch	P	v	f	P

Good luck

T.

ترجمتها	المهارة / رقمها
يسأل ويجيب عن اسئلة عامة واساسية	Ask and respond to basic questions <u>9</u>
التحدث عن المشاعر بجمل او كلمات قصيرة	Talk about feelings in a simple and short sentences <u>14</u>
قراءة الكلمات والجمل البسيطة بصوت عالٍ	Read aloud simple words and sentences <u>23</u>
التعرف على ضمائر الفاعل وتطبيقها بشكل صحيح	Recognize and apply subjective pronouns <u>12</u>
يتعرف ويطبق صيغة الجمع المنتظمة باستخدام هؤلاء واولئك للقريب والبعيد	Recognize and apply regular plural formation using (these and those) <u>11</u>
التعرف على حروف الجر للمكان (على - في)	Recognize prepositions of place (on - in) <u>13</u>
التعرف على نطق الحروف الطويلة والقصيرة	Recognize short and only some long vowels As in pin & pine <u>2</u>
التعرف والتمييز بين نطق بعض الحروف	Recognize and differentiate between some English letters (p & b , f & v) <u>3</u>
التعرف ونتاج بعض الاصوات عند نطق حرفين مع بعض مثل ch sh ,	Recognize and produce some English diagraphs letters (sh _ ch) <u>4</u>
القيام بالكتابة المتحكم فيها مثل توريد الحروف والكلمات الناقصة	Do controlled writing such as supplying missing letters and words <u>34</u>